



# Installation Instructions Heat Pipe

*Solarthermal – Powerful – Long-living*

# Installation Instructions for:

## HP (Heat Pipe) collector systems



### General safety

Solar thermal panels generate heat when exposed to sunlight. All parts such as pipes, connectors, sensors, etc. pose the risk of injury from hot surfaces. In addition, solar thermal systems are operated with overpressure. When a solar thermal system is open, this can lead to leakage of steam or hot water. People who work on solar thermal systems must take this into consideration and must wear protective clothing and follow safety procedures.

The vacuum tube sets are transported horizontally. They may be stacked on a maximum of 7 cartons. Our mounting kits are valid for all snow load zones (except zone 3). In storm areas special static calculations must be performed.

### Safety notice:

Helmet, ear protection, and protective goggles must be worn! Safety gear against falling is necessary! Vacuum tubes are only to be touched with gloves (gloves are enclosed).

### Required tools:

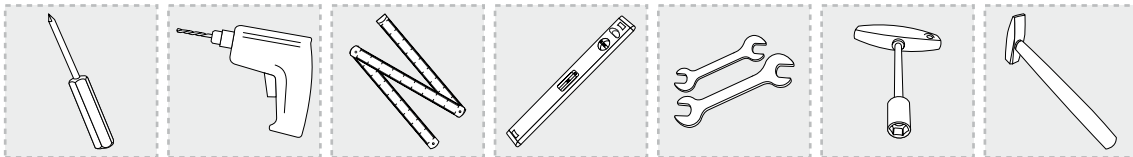

### Possible types of installation

Flat roof, facade, roof tile (tile), trapezoidal sheet metal roof, pitched roof, plate fold roof



### Attention!

The collectors must be mounted so that the header is in position on top. Please note that the tubes must be aligned to the sun! The collector set up angle should be min. 20° to max. 70°.

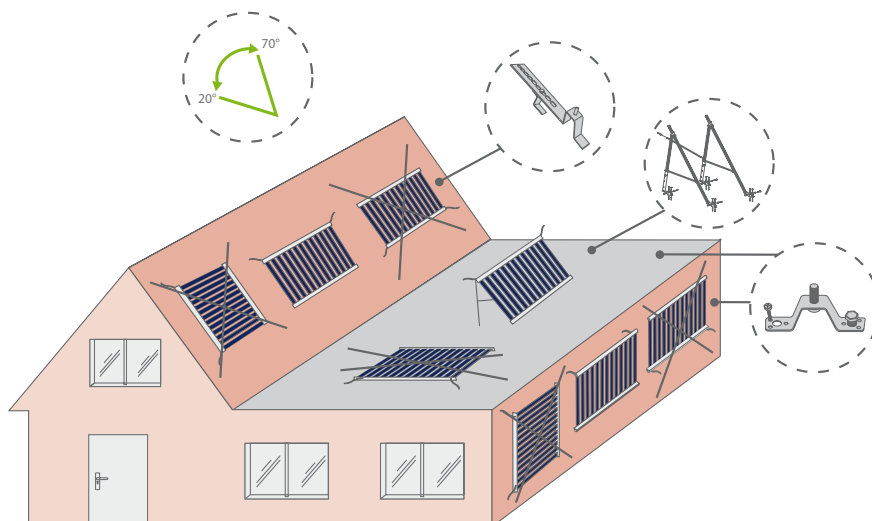

# Installation Instructions for:

## HP (Heat Pipe) collector systems

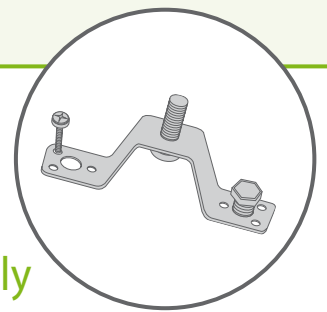

### Wall and or facades-, trapezoidal sheet metal assembly

Set up of the hat profiles in the facade and collector elevation. When mounting on a wall or facade, the hat profiles are to be installed vertically. **Advice:** when mounting the collectors flat on the roof or on facades, the use of the collector stabilizer set is recommended. (Art.Nr.: 791029) Page 4

	A	B	C	D	E	F	G	H
HP10	750	75	150	220	600	450	300	1950
HP20	1500	300	370	450	900	750	600	1950
HP30	2250	450	520	600	1350	1200	1050	1950

The slots allow deviations of +/- 30 mm.

H = 1950 mm

1 Mark, drill, 2 set the dowels, 3 fix the hat profile with key screw NW 13 mm, with trapezoidal sheet metal and flat roofs with appropriate screws 3a.

### Trapezoidal sheet metal assembly / roof and wall:

Screw the hat profiles onto the profiled sheeting using self tapping drill screws (gasket: silicone, etc.) Collector assembly as in all other types of fastening.

## HP (Heat Pipe) collector systems

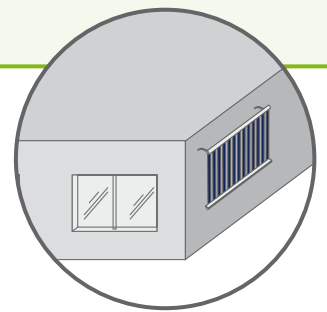

### Collector stabilizer set:

**Advice:** When mounting on facades, the collector stabilizer set is to be installed according to the images 1 and 2. The collector stabilizer set is to be positioned optionally at the free long holes of the connection bar of the header and footer.

**Mounting sequence:** First mount the header and footer based on the installation instructions as usual with the corresponding collector connection set and afterwards mount the stabilizer.

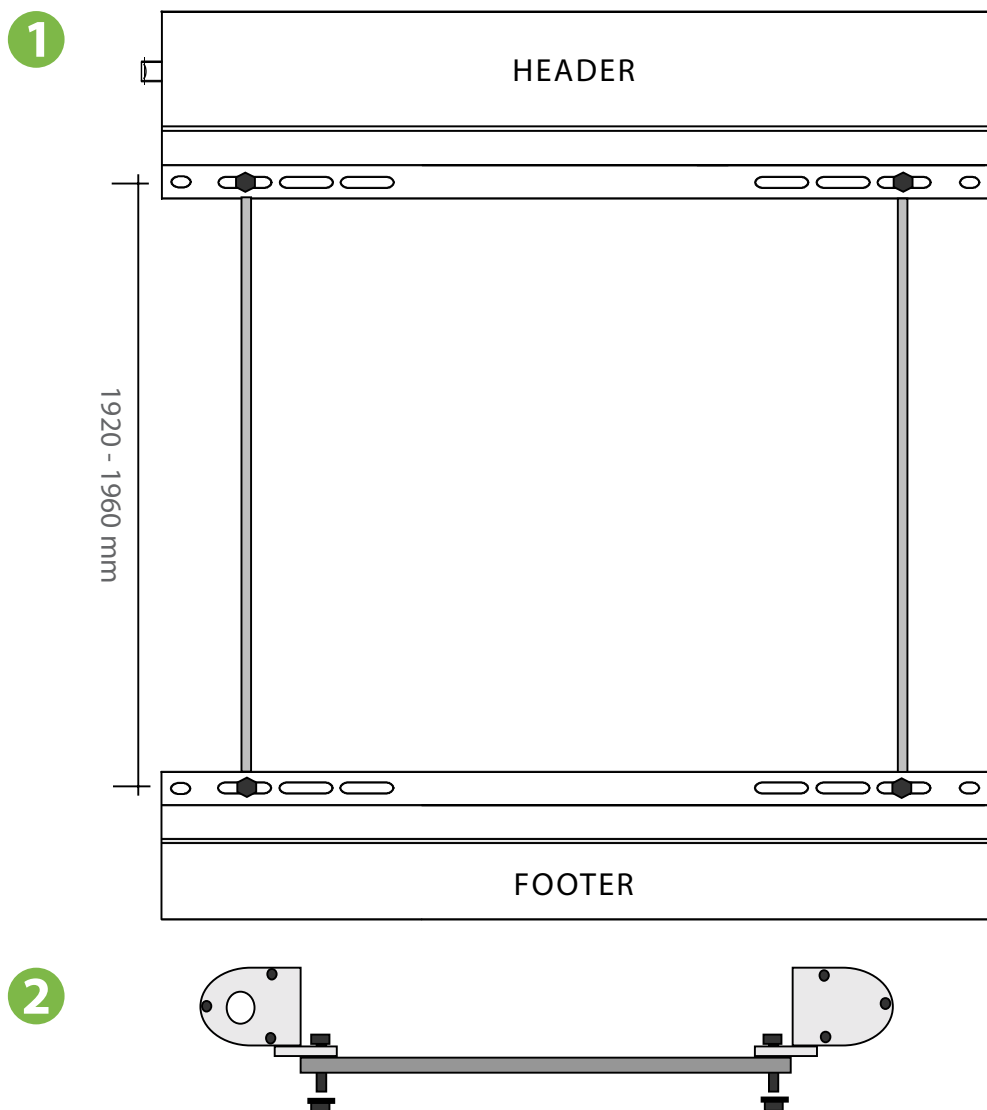

# Installation Instructions for:

## HP (Heat Pipe) collector systems

### Tiled roof mounting

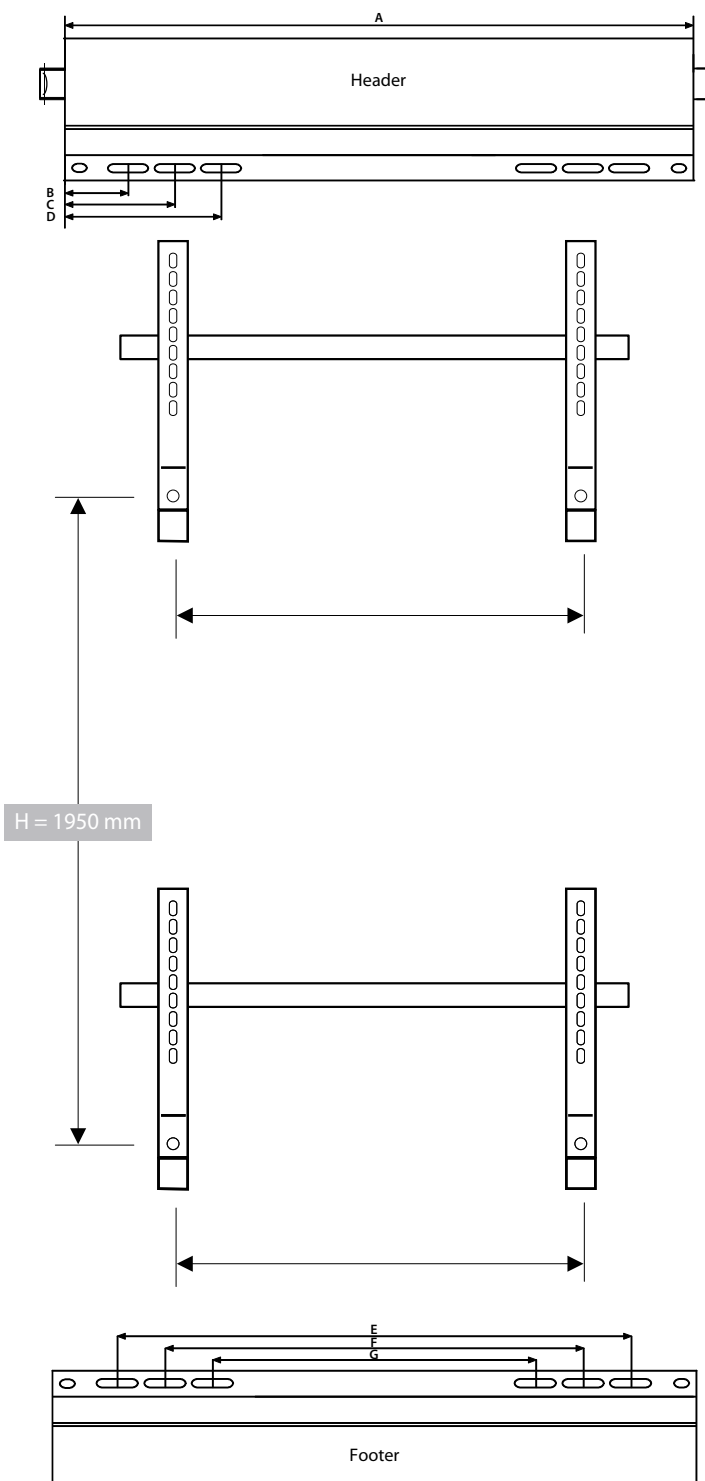

	A	B	C	D	E	F	G	H
HP10	750	75	150	220	600	450	300	1950
HP20	1500	300	370	450	900	750	600	1950
HP30	2250	450	520	600	1350	1200	1050	1950

The slots allow deviations of + / - 30 mm.

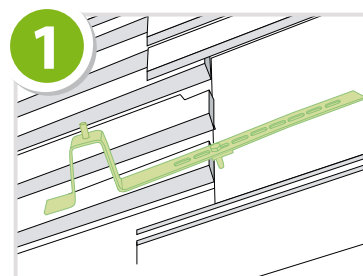
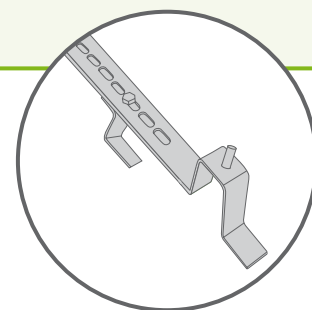

**1** Determine type of tile roofing tile/saddle stone: Then either push up or remove.

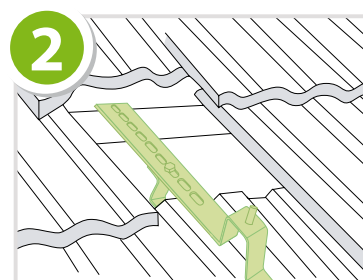

**2** The use of roof hooks: Hang the roof hooks with the hook tie into the counter battens and fix with screw mount M8/SW13.

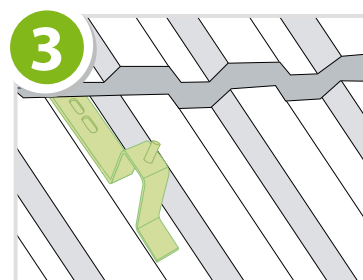

**3** Closing of the tile roof: After possible manipulation move the corresponding roofing tile/saddle stone back into position.

## HP (Heat Pipe) collector systems

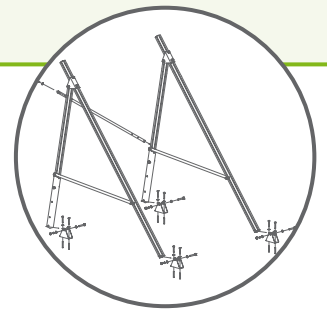

### Mounting with the flat roof mount frame

Mounting sequence for this particular fastening-parts kit:

- A** Fastening of the holders-note the distance. (4x)
- B** Installation of the side rail at the holders in front. (2x)
- C** Installation of the elevation foot at the holders in the back. (2x)
- D** Adjustment and connection of the side bar. (2x)
- E** Installation and fixation of the rear bars. (1x)
- F** Mounting the header and the foot rails onto the side rails. (2x)

### Necessary tools:

Measuring tape, pencil, water level, impact drill with stone drill  $\varnothing$  10mm, flat wrench SW 13, flat wrench SW17

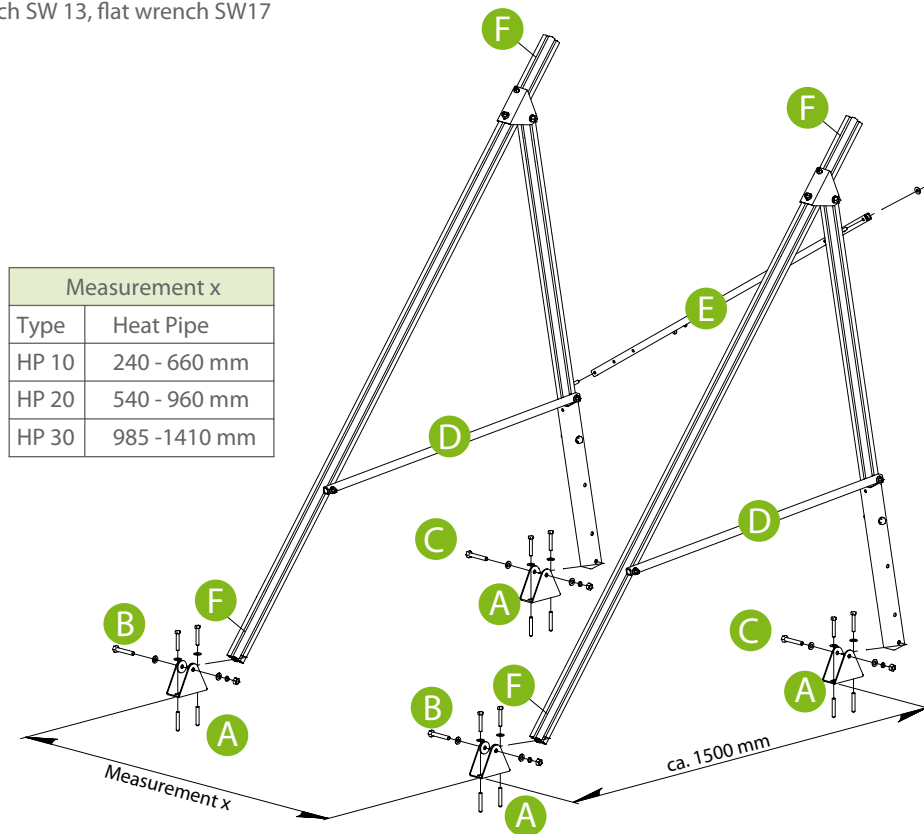

Measurement x	
Type	Heat Pipe
HP 10	240 - 660 mm
HP 20	540 - 960 mm
HP 30	985 - 1410 mm

**Important!** Set up and max. pressure of the base construction on flat roofs approved by DIN 1055/4.

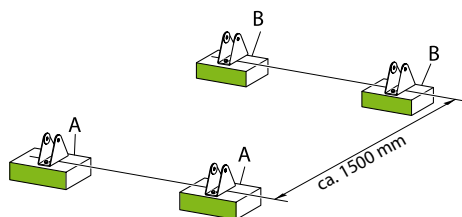

Height over ground	m	up to 8		
Collector type		10er	20er	30er
Weight per support A	kg	40	60	80
Weight per support B	kg	50	70	90

For horizontal installation of the collectors only „weight per support A“!

Height over ground	m	up to 8-20		
Collector type		10er	20er	30er
Weight per support A	kg	55	75	95
Weight per support B	kg	65	85	105

## HP (Heat Pipe) collector systems

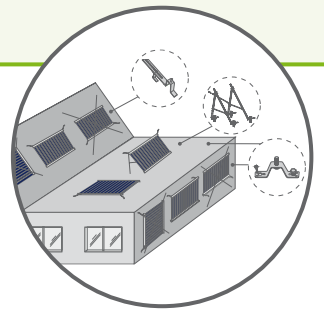

### Lining up collectors, connecting the header:

First, align a header, mount and tighten the mounting screws. Subsequently connect the following header with the HP connector to the already mounted header and couple with slightly rotating movements and only a little pressure. Check whether the connection snapped by pulling slightly.

In order to couple the following header, it may be necessary to rotate the header 90 ° up and then move the header into position.

**Important!** Collectors must be mounted flush to each other, otherwise there may be leaks.

Coupling of headers together: ①

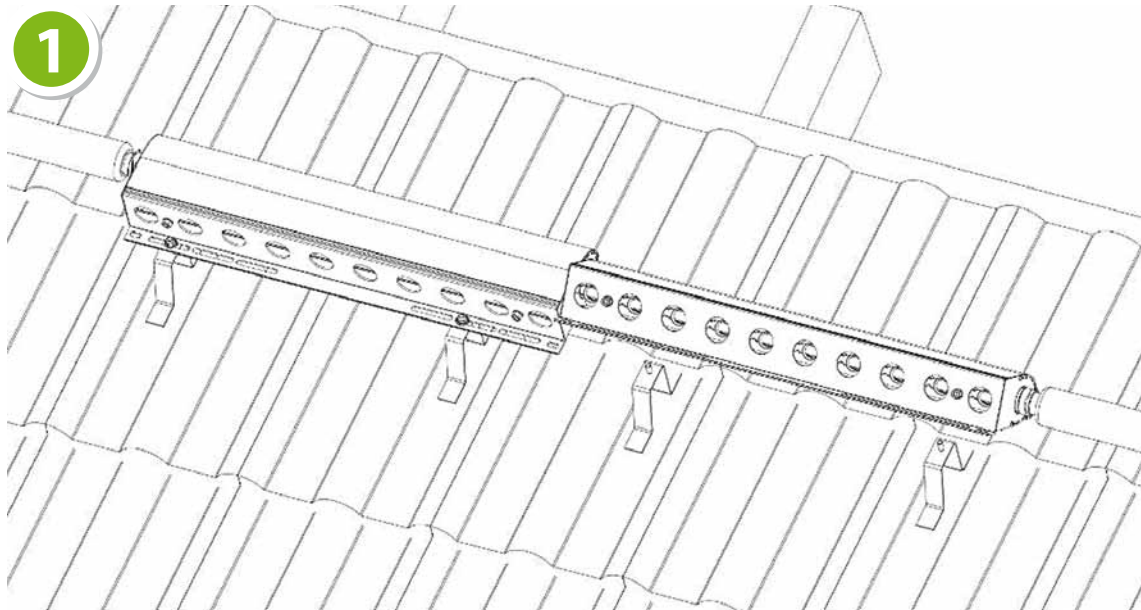

Check coupling when pulling slightly, position header on the roof hook and secure with bolt nut M8: ②



## HP (Heat Pipe) collector systems

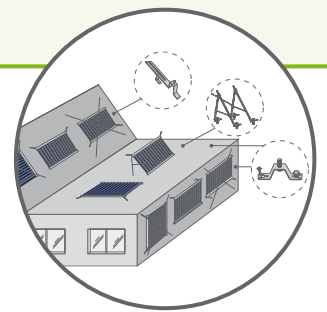

### Mounting the support brackets:

Fastening nut M8 - with bolt **4+5**

When mounting multiple panels in one row, one has to ensure that the header and the support brackets are mounted flush.

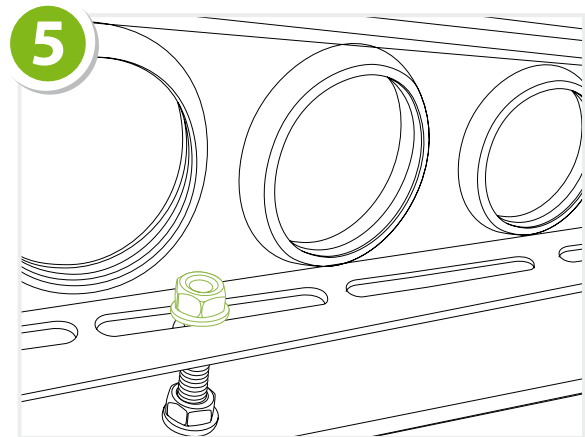
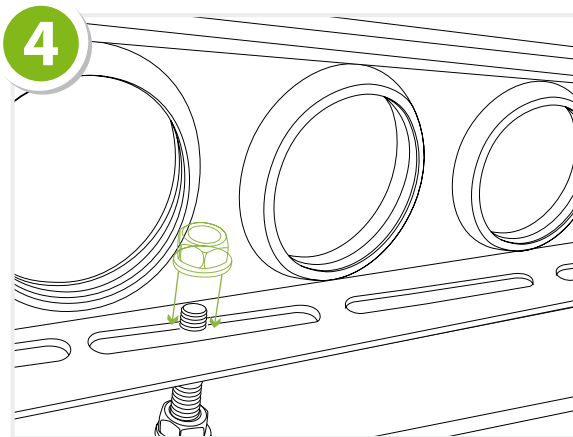

Subsequent slide the tubes in. **Important!** Spray rubber rings at the foot with a soap/water mixture, so that the vacuum tubes can easily insert. **6** Wear cotton gloves.

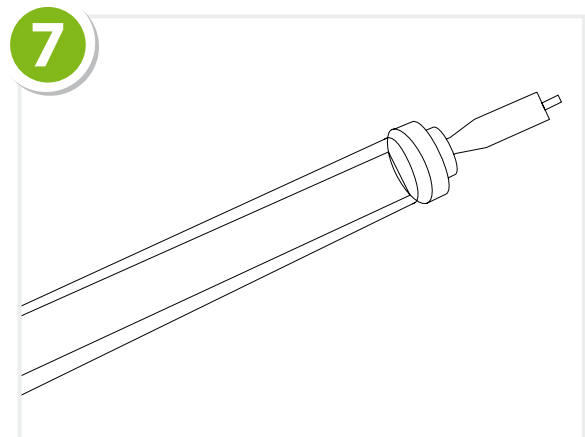
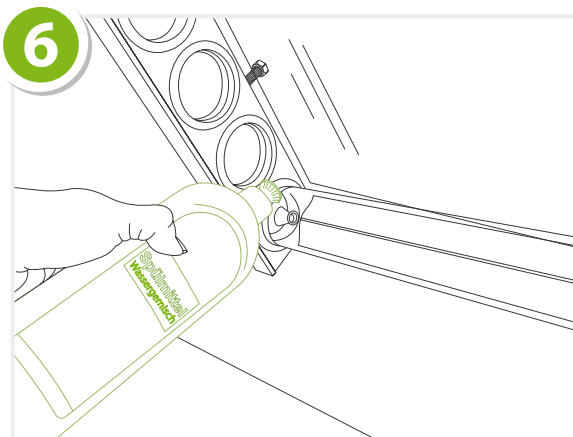

Insert the HP tube **7** with slightly rotating movements into the connection bracket in the header. Insert so far until the tube-safety-rubber touches the header, then pull back approx. 5 mm. **8**  
Check the lock by lightly pulling.

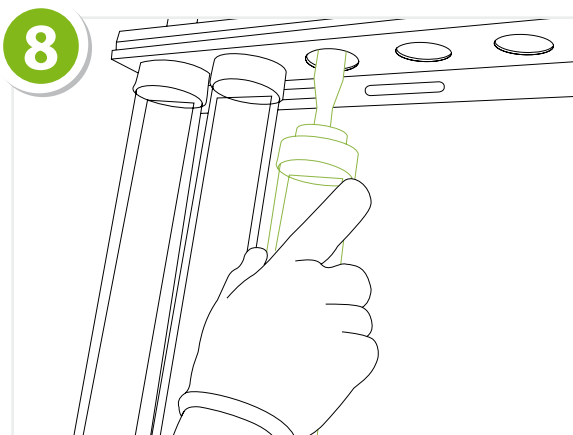



# Installation Instructions for:

## HP (Heat Pipe) collector systems

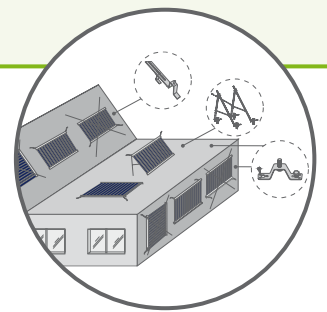

### For all types of installation:

Mounting the cover for the support brackets:

Insert the cover in the roof connection. 9 Rotate the cover at the support bracket. 10

11 Lock the cover into place.

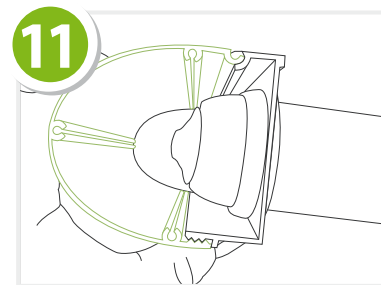
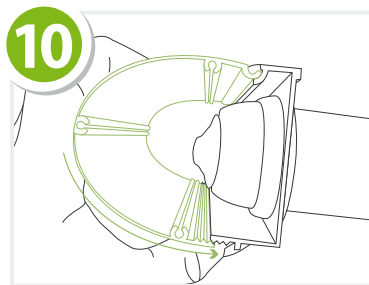
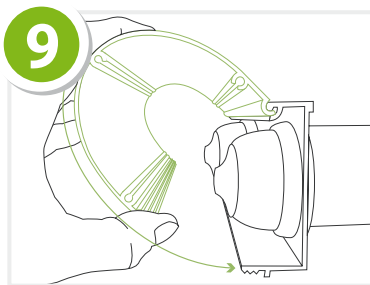

Mounting the side cover:

Position the side cover 12 and secure it with screws on the support bracket. 13

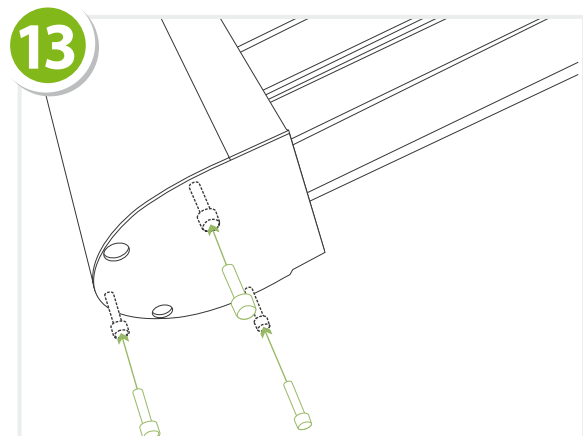
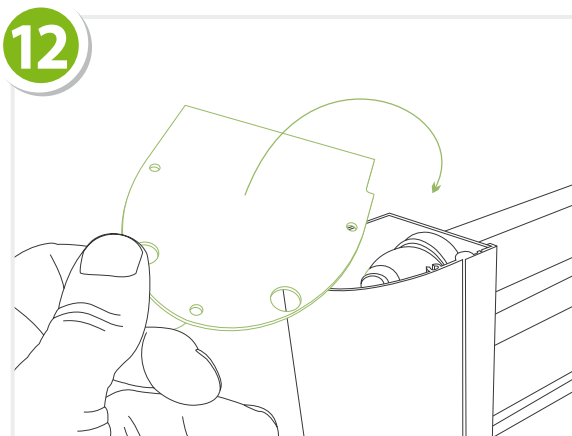

# Installation Instructions for:

## HP (Heat Pipe) collector systems

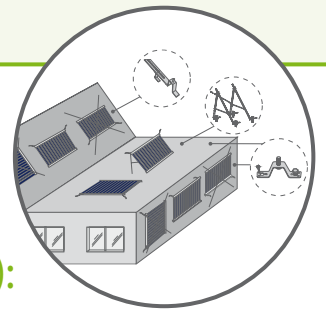

### Mounting the connector (flexible hose or rigid piping):

Mount the side cover onto the exit side of the collector and clip the connector with the sensor pocket onto it. After that insert with slightly rotating movements the flexible hose or rigid piping. **14**

**Important!** Check lock by pulling slightly.

Mount the side cover onto the entrance side of the collector and subsequently insert the flexible hose or rigid piping with slightly rotating movements. **15**

**Important!** Check lock by pulling slightly.

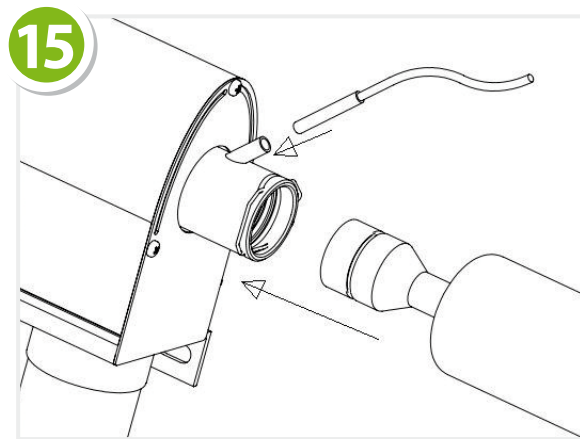
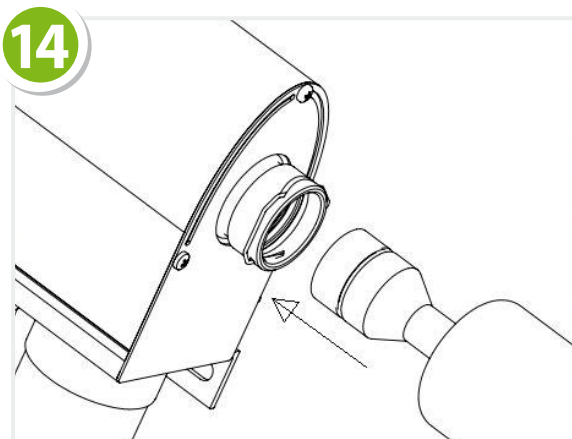

### Mounting the sensor:

Insert the sensor and connect to the shrink hose. Shrink the shrink hose with a heating source or surround it with attached protective tape.



### Attention!

With the use of the rigid piping the fixed point of the pipeline should be determined in such a way that a sufficient expansion of the collector header tube is possible.

# Installation Instructions for:

## HP (Heat Pipe) collector systems

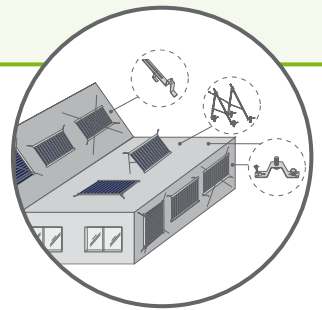

### Operating pressure:



The operating pressure (min. operating pressure) of the system  $P_0$  needs to be set in cold condition (20° C) in a way that a pressure of 1,5 bar will develop at the height of the collector (header).

#### Example:

The collector was mounted  $h=10\text{m}$  above the **expansion vessel**.

$$P_0 = (h \times 0,1) + 1,5 \text{ bar}$$

$$P_0 = (10 \times 0,1) + 1,5 \text{ bar}$$

$$\underline{P_0 = 2,5 \text{ bar}}$$

When in pressure less condition, the pre-pressure of expansion vessel needs to be set between 0,3 - 0,5 bar below the system pressure  $P_0$ .

HP (Heat Pipe) collector systems

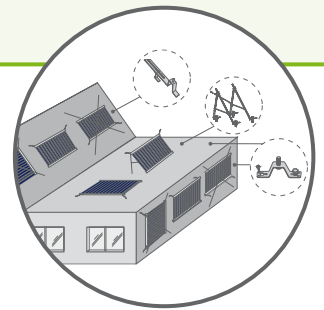

Mounting dimensions HP collectors

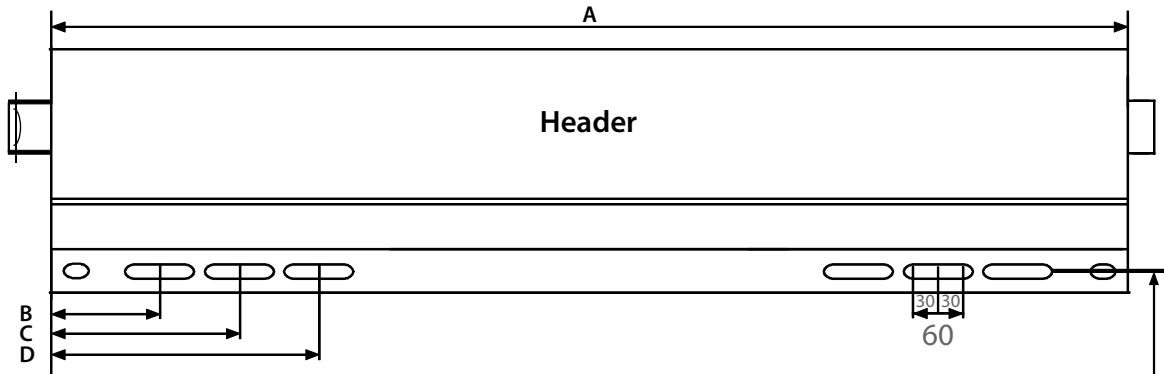

	A	B	C	D	E	F	G	H
HP10	750	75	150	220	600	450	300	1950
HP20	1500	300	370	450	900	750	600	1950
HP30	2250	450	520	600	1350	1200	1050	1950

The slots allow deviations of + / - 30 mm.

**Example to determine the roof hooks** – The position with 3 HP20 collectors  
(medium long hole from roof hook to roof hook)

Hooks 1: measure C ; Hooks 2: measure F ; Hooks 3: measure C+C ; Hooks 4: measure F ;  
Hooks 5: measure C+C ; Hooks 6: measure F

Hooks 1: 370 mm ; Hooks 2: 750 mm ; Hooks 3: 740 mm ; Hooks 4: 750 mm ;  
Hooks 5: 740 mm ; Hooks 6: 750 mm

The hooks for the footer are mounted symmetrically with the distance: dimension H.

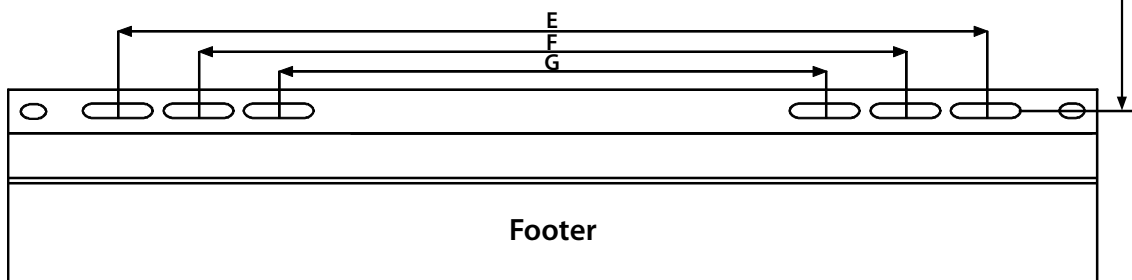

## HP (Heat Pipe) collector systems

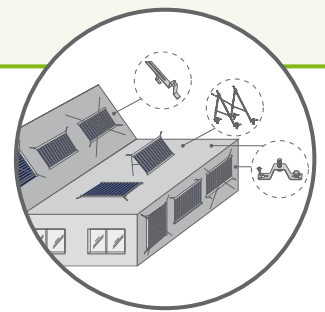

### Collector connections:



### Attention!

Always install the sensors at the feed-in side of the collector (right hand side).

Possible connections for one collector:

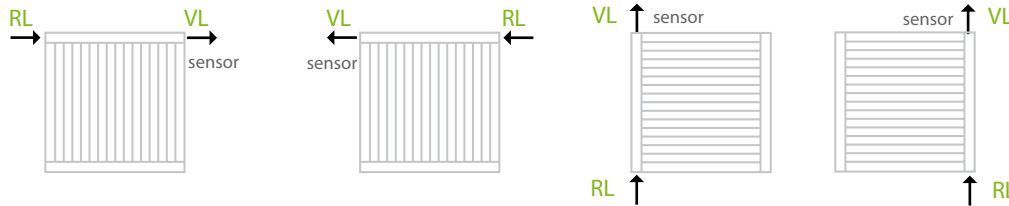

Possible connections for various horizontal installed collectors in a row (max. 70 tubes):

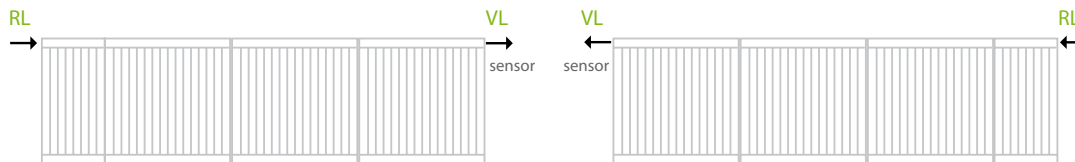

Possible connections for various horizontal installed collectors in a row and parallel (max. 70 tubes):

When connecting the collectors in parallel, attention has to be paid to identical seize (quantity of vacuum tubes) and a clean connection based on „Tichelmann“.

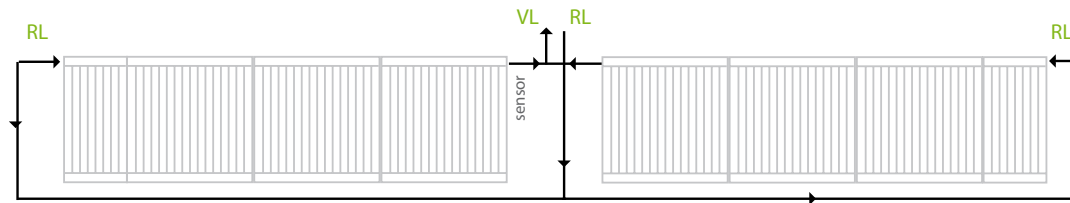

Possible connections for various collectors connected vertically in a row and parallel (max. 70 tubes):

When connecting the collectors in parallel, attention has to be paid to identical seize (quantity of vacuum tubes) and a clean connection based on „Tichelmann“.

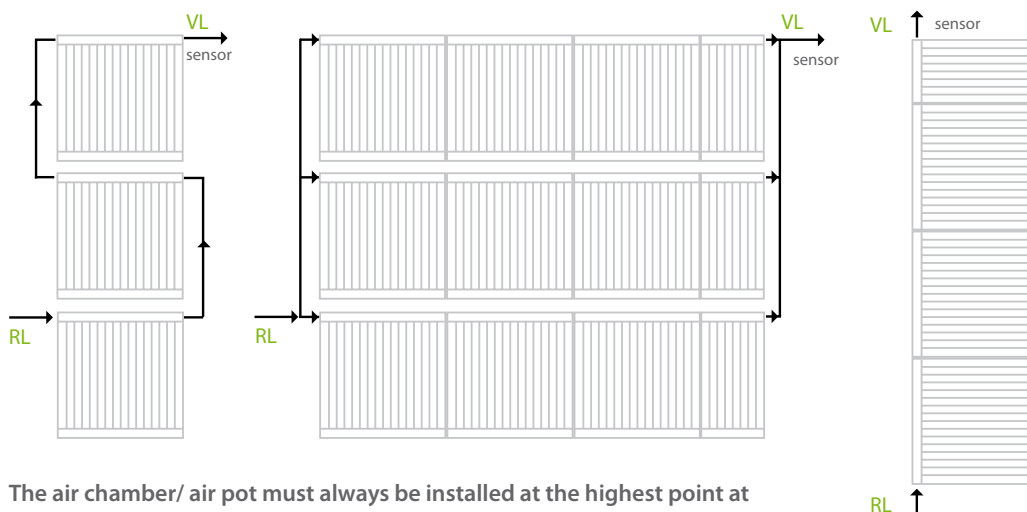

The air chamber/ air pot must always be installed at the highest point at the feeding side of the solar system (mandatory):

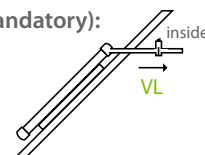

## HP (Heat Pipe) collector systems

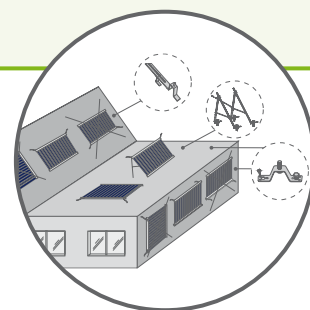

### Check list:

Important points which must be noted:

1. **Insert the vacuum tube with slightly rotating movements into the header.**
  - Remove the safety cap from the vacuum tube.
  - Check connection by pulling slightly.
  - Spray the vacuum tube with a soap-water mixture, this eases the installation of the tubes.
  - Wear cotton gloves.
  
2. **Attention! Do not use any automated exhaust fan with the solar system!**
  - Frequently occurring errors, because it is very common with standard furnace systems.
  - Automated exhaust fans can be destroyed with high temperatures.
  - Heat carrier fluid leaks, therefore the freezing protection is not guaranteed.
  - Operational capability of the system is not guaranteed anymore. Use air chamber/air pot with a manual air-vent screw.
  
3. The heat carrier fluid must be filled using an electrical flush pump/solar filling station. Minimum flushing time up to 30 min. Please make sure that the heat carrier fluid does not contain any air pockets.  
The filling amount depends on the quantity of the installed collectors and the length of the pipes.  
Guidelines for the filling quantity, refer to point 4.
  
4. Program the solar station to a sufficient volume stream of the heat carrier fluid! The regulated volume stream must be set up in the TDC3-controller (litr./h).
  
5. For safe operation of the solar expansion vessel a solar line vessel is to be used.

Tube quantities	20	30	40	50	60	70	80	100	120	140
Heat carrier fluid Volume stream *	1,35-1,70 l/min.	2,00-2,50 l/min.	2,65-3,40 l/min.	3,30-4,25 l/min.	4,00-5,00 l/min.	4,65-5,95 l/min.	5,30-6,80 l/min.	6,60-8,50 l/min.	8,00-10,00 l/min.	9,25-11,75 l/min.
Heat carrier fluid S-Sol VT50 (ca.)	15kg	20kg	30kg	35kg	40kg	45kg	45kg	50kg	60kg	65kg

\* Volume stream 40 - 45 l/m<sup>2</sup>/h (aperture area)



### Attention!

We point out explicitly that the heat carrier fluid used in the system must be S-Sol VT50/VT100 or an alternative tested by us in order to guarantee a long term safe operation of the solar system.

### Maintenance direction

- The anti-freeze content of the heat carrier fluid must be checked annually!
- The safety devices (safety vent and expansion vessel) must be checked annually!
- The functioning of the control unit and all electronic components must be checked on a regular basis!

## HP (Heat Pipe) collector systems

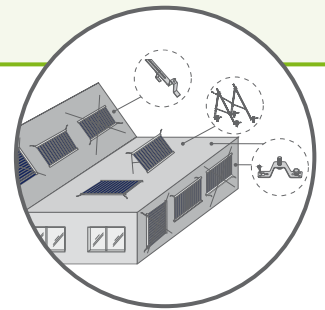

### Pressure loss curve HP10

6. The below shown pressure loss curve is based on a 10 tube HP collector. In order to determine the pressure loss of an entire collector field, the pressure loss needs to be multiplied by the quantity per 10 HP tubes.

**Example:** Collector field with 60 HP tubes in one row:

Volume stream 60 HP tubes (as of chart 4 page 14):  $x = 4,5 \text{ ltr/min} = 270 \text{ ltr/h}$

Druckverlust:  $y = 0,0002916 \cdot x^2 + 0,0060511 \cdot x$

$$y = 0,0002916 \cdot (270 \cdot 270) + 0,0060511 \cdot 270$$

$$y = 21,26 + 1,63$$

$$y = 22,89 \text{ mbar/10 HP tubes}$$

$$y = 22,89 \text{ mbar} \cdot 6$$

$$\underline{\underline{y = 137,36 \text{ mbar/60 HP tubes}}}$$

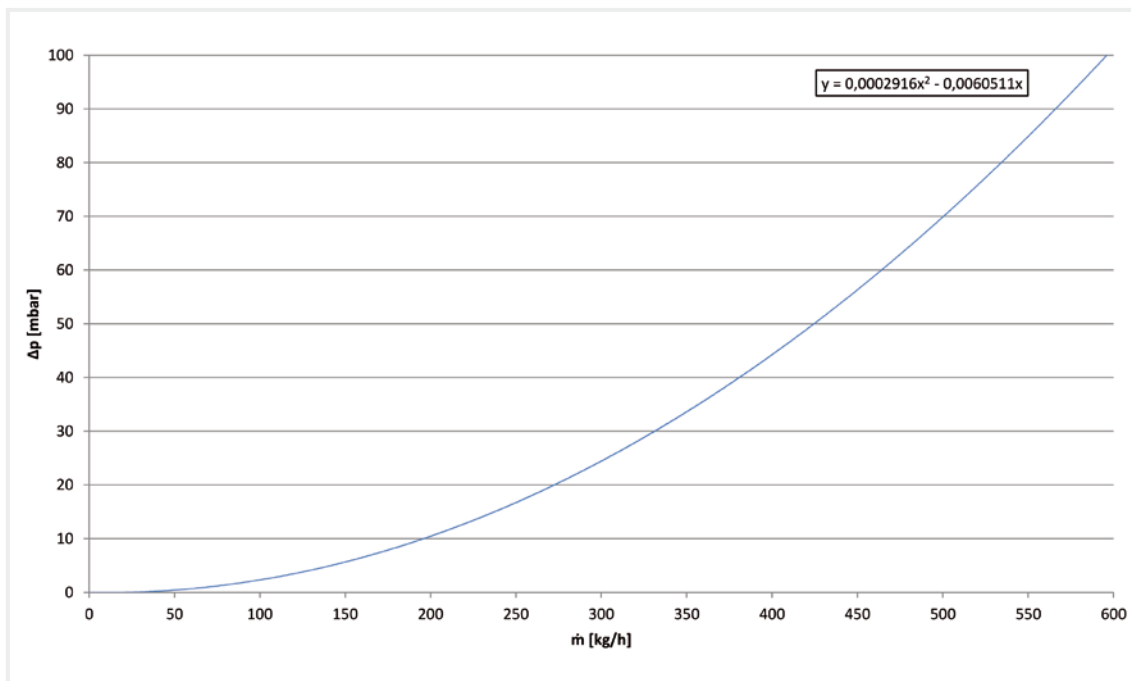

#### 7. Dimensioning the expansion vessel:

Tube quantities	20	30	40	50	60	70	80	100	120	140
Solar line vessel	5 l	5 l	5 l	5 l	12 l	12 l	12 l	18 l	18 l	18 l
Solar expansion vessel	18 l	18 l	25 l	25 l	25 l	35 l	35 l	50 l	50 l	80 l

8. The water tank must be dimensioned between 50 l und 70 l/m<sup>2</sup> gross collector area.
9. In case that no s-power control unit is used, the alternative controller needs to feature a vacuum tube collector function.
10. The pipes used in the solar system must be sufficiently insulated.
11. The collector field must be grounded against lightning strike according to the local regulations.

# s|power<sup>®</sup>

Entwicklungs- & Vertriebs GmbH

Industriestraße 24-27  
49716 Meppen  
Germany

Fon: + 49 5931 88388-0  
Fax: + 49 5931 88388-99

E-Mail: [info@s-power.de](mailto:info@s-power.de)

[www.s-power.de](http://www.s-power.de)

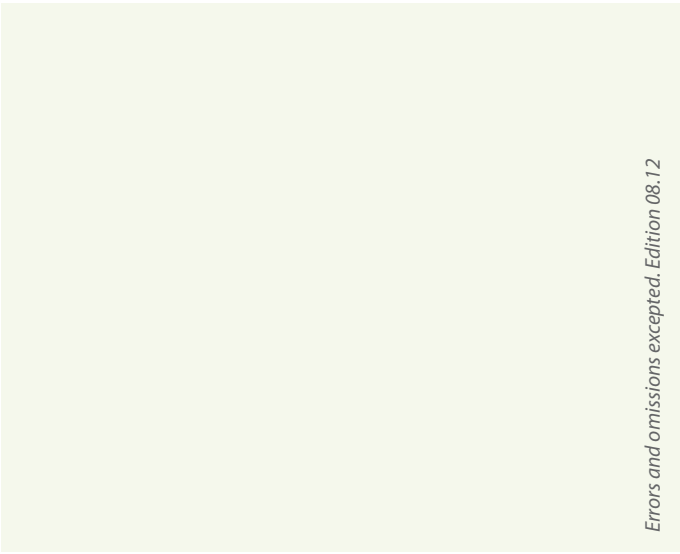

Errors and omissions excepted. Edition 08.12

